



Electrical Appliances





Here's to new beginnings!

Pyramis Metallourgia A.E. is a Greek multinational company supplying integrated kitchen and bathroom solutions for domestic use. With over 60 years of expertise, Pyramis is among the top leading companies of the sector worldwide (production capacity of 1,500,000 stainless steel sinks & 170,000 composite sinks annually). Its international sales account for more than 85% of total company's turnover, with almost 97% of its production exported to 82 countries all over the world.

In 2022, in a brand new factory, at Oinofyta, Athens, Pyramis is redefining "Made in Greece" quality, incorporating the highest design and functionality standards, in creating new domestic appliances and seamless smart home experiences. In a changing and transforming world, there are timeless values connecting the past, present and future, defining a sustainable and practical daily life. At Pyramis, we support this connection by fostering an outward looking culture of excellence, continuous development and innovation.

Cookerhoods

Smooth design, minimal lines, fine quality and superior functionality are only some of the features of Pyramis cooker hoods.

The rest, come in a variety of types, sizes, colors and capacities in order to provide maximum results according to your needs. But all of them guarantee that the Pyramis cookerhoods provide a room free from odors and vapors. They work quietly but efficiently and they keep the aroma of the food on your plate and not all over the house.



Cookerhood Types

Pyramis cooker hoods offer an abundant variety of types: Standard hoods, sliding, integrated, chimneys, decorative hoods, islands... all made of quality materials to offer your kitchen the design and the performance it requires.



Abysso, a new experience!

Abysso is a unique solution for the kitchen, as it brings together an induction hob with a built-in cooker hood under the workbench. An evolution in both aesthetics and performance, it combines the perfect design and extraction capacity and starts a revolution in the cooking experience in an innovative way: an odorless kitchen with complete visual freedom.



Key Features

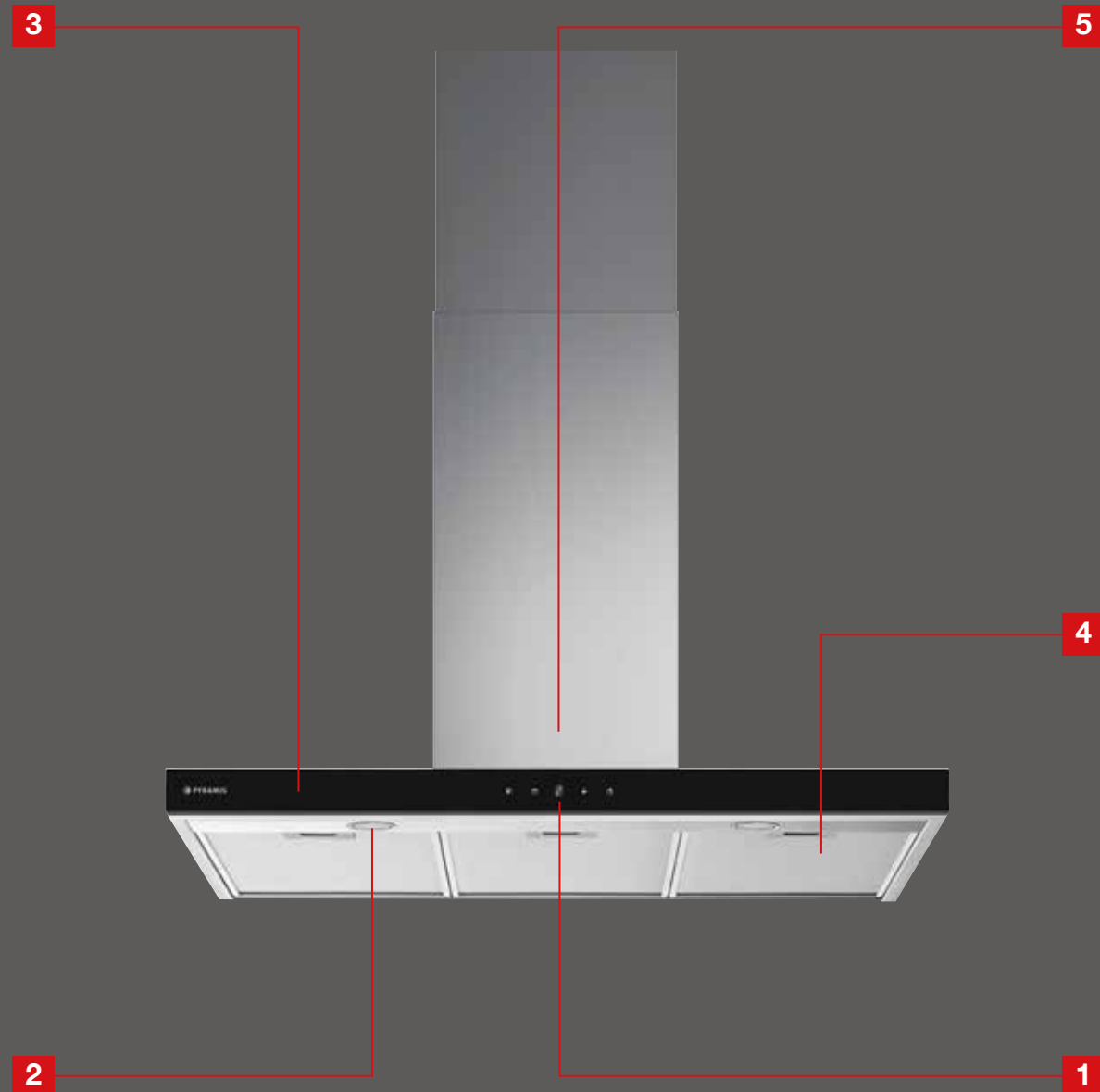

1
Device control

Touch control, functional push sliding or electronic buttons, ensure easy to use appliances and excellent aesthetics.



2
Lighting

The use of LED lighting ensures efficient & constant light flow, longer life cycle and energy saving.



3
Materials

Pyramis cookerhoods are offered in various materials and color combinations so that they can match your kitchen style. Glass, stainless steel or painted surfaces and their combinations are just some of the options that you can choose from.



4
Metallic filters

They protect the inner parts of the cookerhood by preventing the absorbed grease from harming the fan or the motor and add to the aesthetics of the cooker hood. They are easy to remove and can be washed by hand, or in the dishwasher.



5
Carbon filters

Carbon filters recirculate the purified air back to your kitchen. They cannot be cleaned or repaired; they can only be replaced when necessary. Their saturation depends on the level and time of use, type of cooking and the frequency that the metal filters are cleaned.

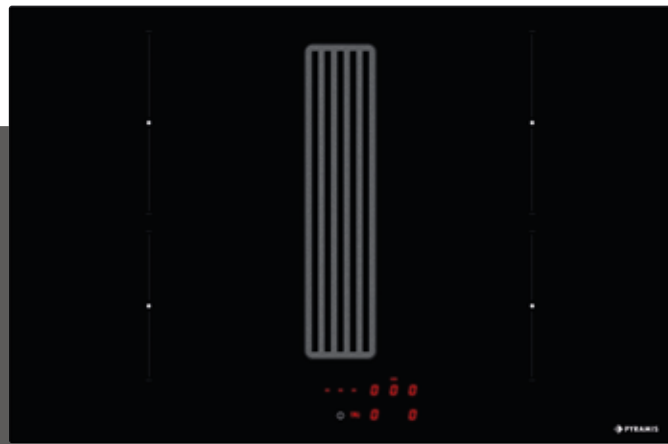

034062201
Abyssos Down Air
78cm

Features

Material: Black glass
Dimensions: 78x51,5cm
Cut out dimensions: 75x49cm
Control: Touch control with slider
Energy class: A

Cookerhood

Extraction rate (IEC): 590m³/h
Power levels: 4+1
Filter saturation indicator
Noise level: 41-61dB
Motor: 160W
Metallic filters: 1

Hobs

9 Function levels
Boost function
Timer
Pause function
Keep warm
Safety lock
Residual heat indicator

4 Induction Zones



065039901
Grandezzo
90cm

065039801
Grandezzo
60cm

Features

Material: Inox & black glass
Width: 90 / 60cm
Extraction rate (IEC): 679m³/h
Extraction rate (free flow): 1000m³/h
Noise level: 48-68dB
Motor: 250W
Power levels: 3
Lighting: LED spots
Control: Touch
Metallic filters: 3 (90cm), 2 (60cm)
Energy class: A



065021701
Corso Ceiling
90cm

Features

Material: Inox & black glass
Width: 90cm
Extraction rate (IEC): 704m³/h
Extraction rate (free flow): 1000m³/h
Noise level: 43-69dB
Motor: 270W
Power levels: 3
Lighting: LED spots
Control: Touch
Metallic filters: 2
Energy class: C



065033001
Eleganto
90cm

065033101
Eleganto
60cm

Features

Material: Inox & black glass
Width: 90 / 60cm
Extraction rate (IEC): 455m³/h
Extraction rate (free flow): 700m³/h
Noise level: 42-60dB
Motor: 120W
Power levels: 3
Lighting: LED spots
Control: Push buttons
Metallic filters: 1
Energy class: B





065018601
Cilindrico Ceiling
Ø43cm

Features

Material: Inox
Diameter: Ø43cm
Extraction rate (IEC): 496m³/h
Extraction rate (free flow): 650m³/h
Noise level: 47-67dB
Motor: 250W
Power levels: 4
Lighting: LED spots
Control: Electronic buttons
Metallic filters: 1
Energy class: D



065023201
Fiero White
90cm

065023301
Fiero White
60cm

Features

Material: White glass
Width: 90 / 60cm
Extraction rate (IEC): 401m³/h
Extraction rate (free flow): 650m³/h
Noise level: 54-68dB
Motor: 190W
Power levels: 3
Lighting: LED spots
Control: Touch buttons
Metallic filters: 1
Energy class: D



065036401
Agilo
90cm

065036301
Agilo
60cm

Features

Material: Inox
Width: 90 / 60cm
Extraction rate (IEC): 679m³/h
Extraction rate (free flow): 1000m³/h
Noise level: 48-68dB
Motor: 250W
Power levels: 3
Lighting: LED spots
Control: Touch buttons
Metallic filters: 3 (90cm), 1 (60cm)
Energy class: A



065037901
Square Plus Chimney
90cm

065038001
Square Plus Chimney
60cm

Features

Material: Inox
Width: 90 / 60cm
Extraction rate (IEC): 600m³/h
Extraction rate (free flow): 950m³/h
Noise level: 46-64dB
Motor: 180W
Power levels: 3
Lighting: LED spots
Control: Electronic buttons
Metallic filters: 2 (90cm), 3 (60cm)
Energy class: B





065018102
Rustic Chimney
90cm

Features

Material: White metal & wood
Width: 90 / 60cm
Extraction rate (IEC): 435m³/h
Extraction rate (free flow): 600m³/h
Noise level: 56-65dB
Motor: 140W
Power levels: 3
Lighting: LED lamps
Control: Sliding buttons
Metallic filters: 1
Energy class: D



065018002
Rustic Chimney
60cm

065305201
Integrated Plus EF
71cm

065305101
Integrated Plus EF
51cm

Features

Material: Inox
Width: 71 / 51cm
Extraction rate (IEC): 710m³/h
Extraction rate (free flow): 1000m³/h
Noise level: 53-70dB
Motor: 250W
Power levels: 3+1
Lighting: LED strip
Control: Electronic buttons
Metallic filters: 2 (71cm), 1 (51cm)
Energy class: B



065036801
Sliding Turbo Plus Inox
60cm

Features

Material: Inox
Width: 60cm
Extraction rate (IEC): 700m³/h
Extraction rate (free flow): 1000m³/h
Noise level: 49-68dB
Motor: 250W
Power levels: 3
Lighting: LED spots
Control: Electronic buttons
Metallic filters: 2 (stainless steel)
Energy class: A



065305001
Integrated Turbo EF
51cm

Features

Material: Metal grey
Width: 51cm
Extraction rate (IEC): 580m³/h
Extraction rate (free flow): 850m³/h
Noise level: 46-65dB
Motor: 150W
Power levels: 3
Lighting: LED spots
Control: Electronic buttons
Metallic filters: 1
Energy class: B



Ovens

Pyramis ovens have been designed to make cooking as easier and as quicker as possible in order for you to have more time to spend with whatever you love the most.

Cook without compromises and enjoy a tasteful result. The smart as well as the basic functions of Pyramis ovens will come up to the task, either you're a professional mastechef or an inexperienced learner.

They come in a variety of function combinations and styles but all with an extra large cavity of 73lt. Choose what best fits your needs and let yourself get creative in the kitchen, the results will sure amaze you!



Control



Full touch, high advanced with auto programs



Touch control in combination with knobs



Mechanical controls with knobs



Key Features

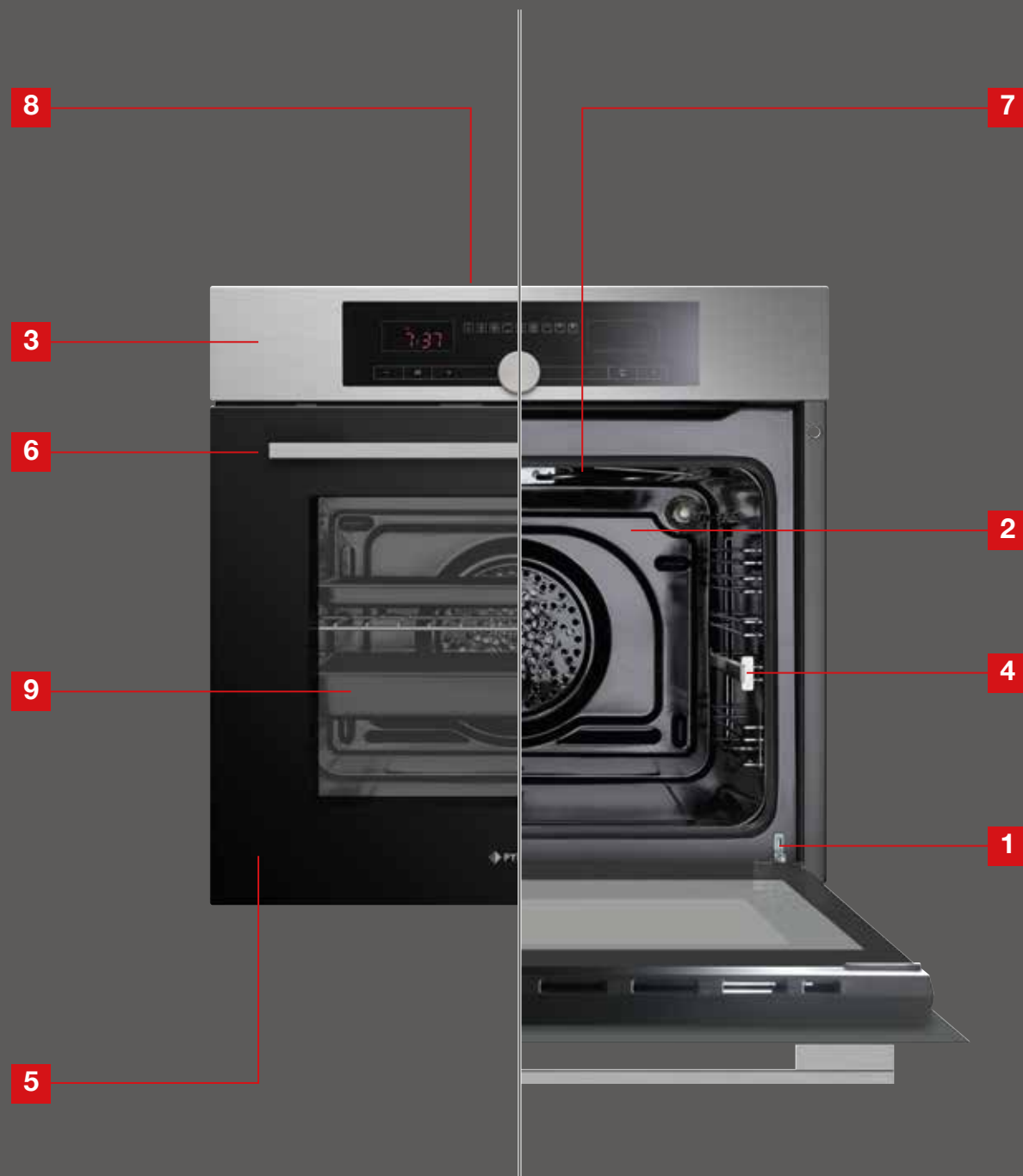

Soft close door

Specially designed hinges, softly and quietly close the oven door with a gentle touch, reducing vibrations and noise.



Easy to clean enamelled cavity

The cavity of the oven is enameled with an extremely durable coating which provides additional insulation, while it does not absorb grease and food residues. Thus, the oven cavity is effortlessly cleaned.



Anti-spot surface

The coating of the external stainless steel surfaces prevents the formation of marks and stains from daily use, keeping them clean for a longer period of time.



Side racks / Telescopic rails

Side racks and telescopic guides make cooking easier and safer while maintaining the cavity intact from scratches.



Double / triple glass door

They maintain heat inside the oven, optimizing energy consumption while keeping the outer surface of the oven door cool and safe. They are easily detachable for cleaning.



Door handles

High aesthetics, durability and ergonomic design are the key features of the new Pyramis oven handles.

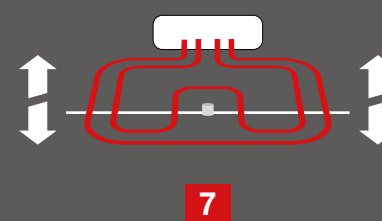

Detachable grill

The upper heating element moves down with a simple touch, so the cleaning of the oven cavity becomes easier than ever.



Cooling system

The ventilation system cools the oven efficiently, maintaining the appropriate temperature both around the oven (cabinets) and at the front (door), ensuring maximum safety & efficiency.



Accessories

Large trays and grids (42x34cm) are provided with every Pyramis oven, for your every day cooking needs.



034068001
Oven TC Inox
731075

Features

Dimensions: 59,5x59,5x57cm
Capacity: 73 litres
Control: Touch
Digital auto programmer
Child lock
Triple glass door with removable inner glasses
Soft close door
4 level side racks & 1 level telescopic guide
Easy to clean enameled cavity
1 deep tray (42x34x5cm), 1 flat tray & 1 grid included
Energy class: A

11 Functions

Upper & lower heating element
Lower heating element
Upper heating element
Grill
Grill & upper heating element
Grill & fan
Lower heating element + Turbo fan (Pizza function)
Upper & lower heating element & fan
Turbo fan
Defrost
Keep warm



034067901
Oven CKLED Inox
732240

Features

Dimensions: 59,5x59,5x57cm
Capacity: 73 litres
Control: Touch with central knob
Digital auto programmer
Child lock
Triple glass door with removable inner glasses
Soft close door
4 level side racks & 1 level telescopic guide
Easy to clean enameled cavity
1 deep tray (42x34x5cm), 1 flat tray & 1 grid included
Energy class: A

9 Functions

Lighting
Defrost
Turbo fan
Upper & lower heating element
Upper & lower heating element & fan
Lower heating element + Turbo fan (Pizza function)
Grill
Grill & upper heating element
Grill & upper heating element & fan



034068101
Oven TC Black
731075

Features

Dimensions: 59,5x59,5x57cm
Capacity: 73 litres
Control: Touch
Digital auto programmer
Child lock
Triple glass door with removable inner glasses
Soft close door
4 level side racks & 1 level telescopic guide
Easy to clean enameled cavity
1 deep tray (42x34x5cm), 1 flat tray & 1 grid included
Energy class: A

11 Functions

Upper & lower heating element
Lower heating element
Upper heating element
Grill
Grill & upper heating element
Grill & fan
Lower heating element + Turbo fan (Pizza)
Upper & lower heating element & fan
Turbo fan
Defrost
Keep warm



034067601
Oven PKLED Inox
731065

Features

Dimensions: 59,5x59,5x57cm
Capacity: 73 litres
Control: Push / pull knobs & digital touch timer
Child lock
Double glass door with removable inner glass
Soft close door
5 level side racks
Easy to clean enameled cavity
1 deep tray (42x34x5cm) & 1 grid included
Energy class: A

9 Functions

Lighting
Turbo fan
Lower heating element
Grill
Grill & upper heating element
Upper & lower heating element
Upper & lower heating element & fan
Grill & upper heating element & fan
Lower heating element + Turbo fan (Pizza function)





034067701
Oven PKLED Black
731065

Features

Dimensions: 59,5x59,5x57cm
Capacity: 73 litres
Control: Push / pull knobs & digital touch timer
Child lock
Double glass door with removable inner glass
Soft close door
5 level side racks
Easy to clean enameled cavity
1 deep tray (42x34x5cm) & 1 grid included
Energy class: A

9 Functions

Lighting
Turbo fan
Lower heating element
Grill
Grill & upper heating element
Upper & lower heating element
Upper & lower heating element & fan
Grill & upper heating element & fan
Lower heating element + Turbo fan (Pizza function)



034067401
Oven PK Inox
731016

Features

Dimensions: 59,5x59,5x57cm
Capacity: 73 litres
Control: Push / pull knobs
Mechanical timer
Double glass door with removable inner glass
5 level side racks
Easy to clean enameled cavity
1 deep tray (42x34x5cm) & 1 grid included
Energy class: A

6 Functions

Defrost
Upper & lower heating element & fan
Upper & lower heating element
Lower heating element
Upper heating element
Grill



034067801
Oven PKLED White
731065

Features

Dimensions: 59,5x59,5x57cm
Capacity: 73 litres
Control: Push / pull knobs & digital touch timer
Child lock
Double glass door with removable inner glass
Soft close door
5 level side racks
Easy to clean enameled cavity
1 deep tray (42x34x5cm) & 1 grid included
Energy class: A

9 Functions

Lighting
Turbo fan
Lower heating element
Grill
Grill & upper heating element
Upper & lower heating element
Upper & lower heating element & fan
Grill & upper heating element & fan
Lower heating element + Turbo fan (Pizza function)



034067501
Oven PK Black
731016

Features

Dimensions: 59,5x59,5x57cm
Capacity: 73 litres
Control: Push / pull knobs
Mechanical timer
Double glass door with removable inner glass
5 level side racks
Easy to clean enameled cavity
1 deep tray (42x34x5cm) & 1 grid included
Energy class: A

6 Functions

Defrost
Upper & lower heating element & fan
Upper & lower heating element
Lower heating element
Upper heating element
Grill





034068201
Oven Rustic Beige Metal
733070

Features
Dimensions: 59,5x59,5x57cm
Capacity: 73 litres
Control: Rustic knobs
Analog timer
Double glass door with removable inner glass
Soft close door
5 level side racks
Easy to clean enameled cavity
1 deep tray (42x34x5cm) & 1 grid included
Energy class: A

9 Functions
Lighting
Turbo fan
Lower heating element
Grill
Grill & upper heating element
Upper & lower heating element
Upper & lower heating element & fan
Grill & upper heating element & fan
Lower heating element + Turbo fan (Pizza function)



034067301
Oven SK Inox
731006



Features
Dimensions: 59,5x59,5x57cm
Capacity: 73 litres
Control: Knobs
Double glass door with removable inner glass
5 level side racks
Easy to clean enameled cavity
1 deep tray (42x34x5cm) & 1 grid included
Energy class: A

Functions
Defrost
Upper & lower heating element & fan
Upper & lower heating element
Lower heating element
Upper heating element
Grill



034068301
Oven Rustic Black Metal
733070

Features
Dimensions: 59,5x59,5x57cm
Capacity: 73 litres
Control: Rustic knobs
Analog timer
Double glass door with removable inner glass
Soft close door
5 level side racks
Easy to clean enameled cavity
1 deep tray (42x34x5cm) & 1 grid included
Energy class: A

9 Functions
Lighting
Turbo fan
Lower heating element
Grill
Grill & upper heating element
Upper & lower heating element
Upper & lower heating element & fan
Grill & upper heating element & fan
Lower heating element + Turbo fan (Pizza function)

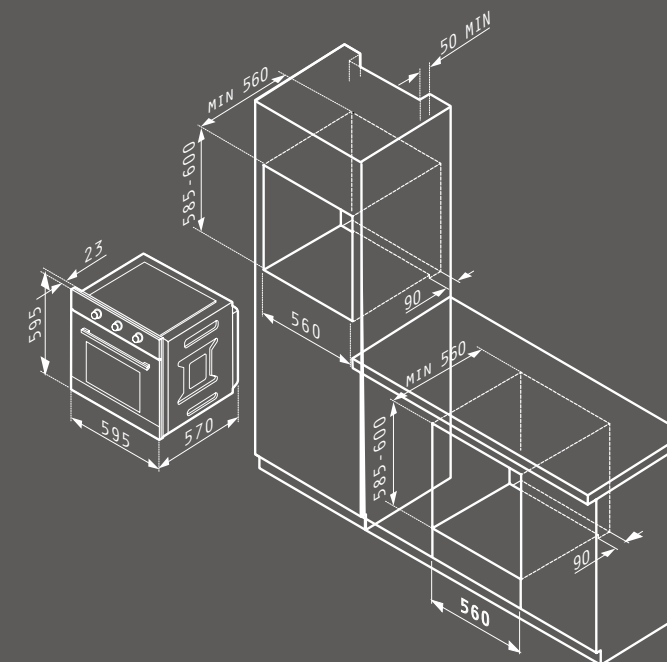

Hobs

Pyramis hobs offer a truly improved experience in cooking.

The refined design and the multitude of types, functions and sizes, ally with the latest developments in technology, and offer the perfect choice for every kitchen. Whether it is ceramic, induction or gas, Pyramis hobs guarantee efficiency and high standard quality in every day meal preparation.

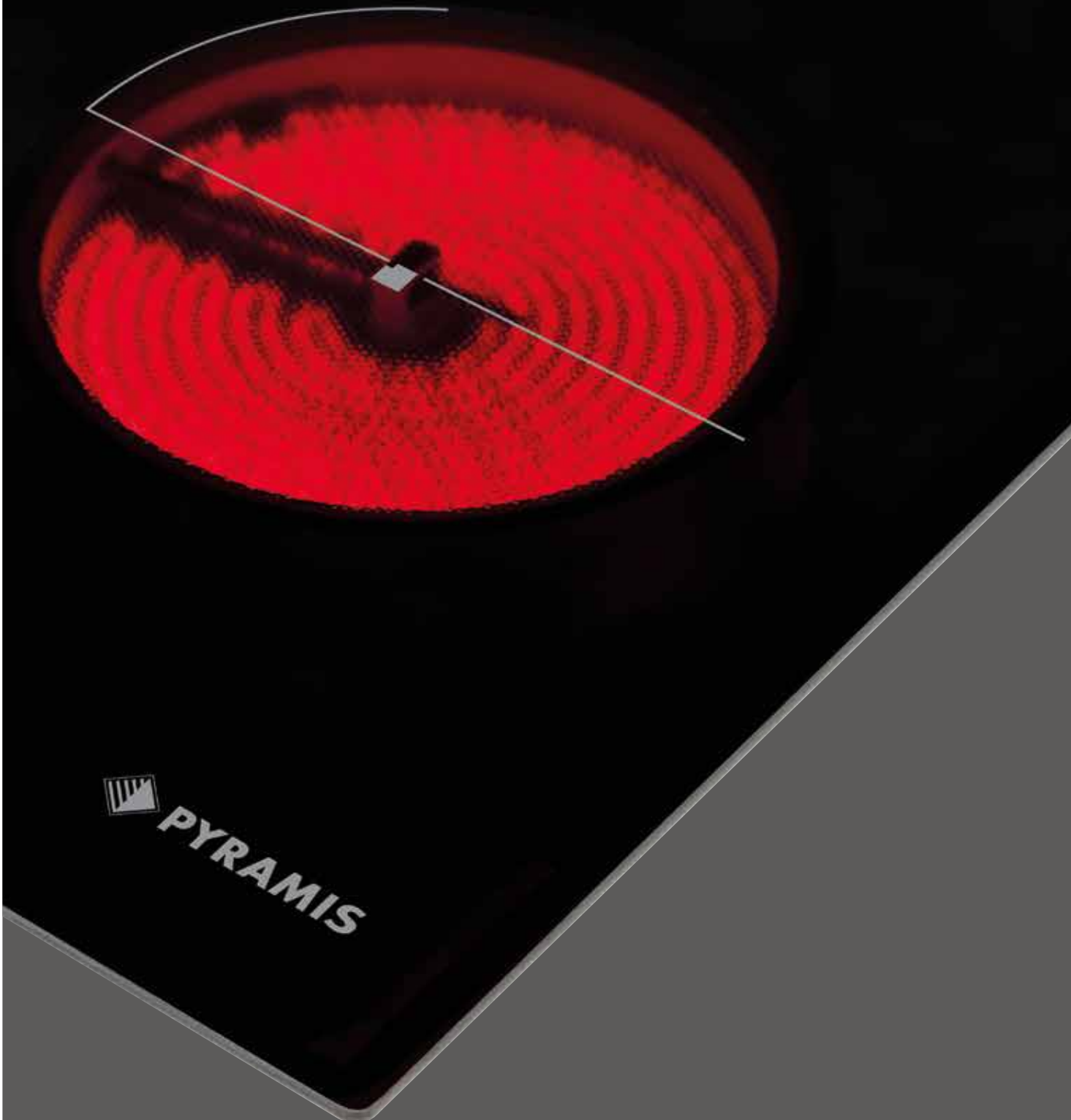

Types



Ceramic



Induction



Gas



Ceramic Hobs

Induction Hobs

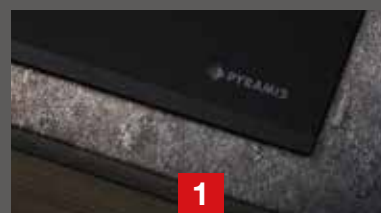
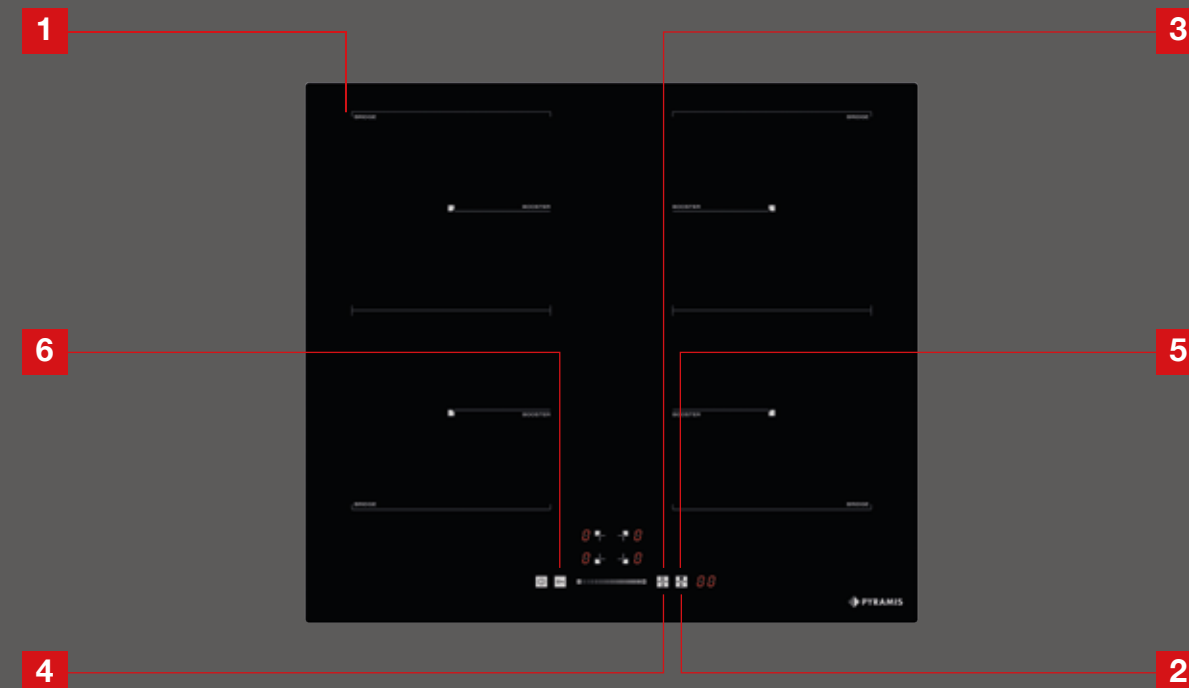
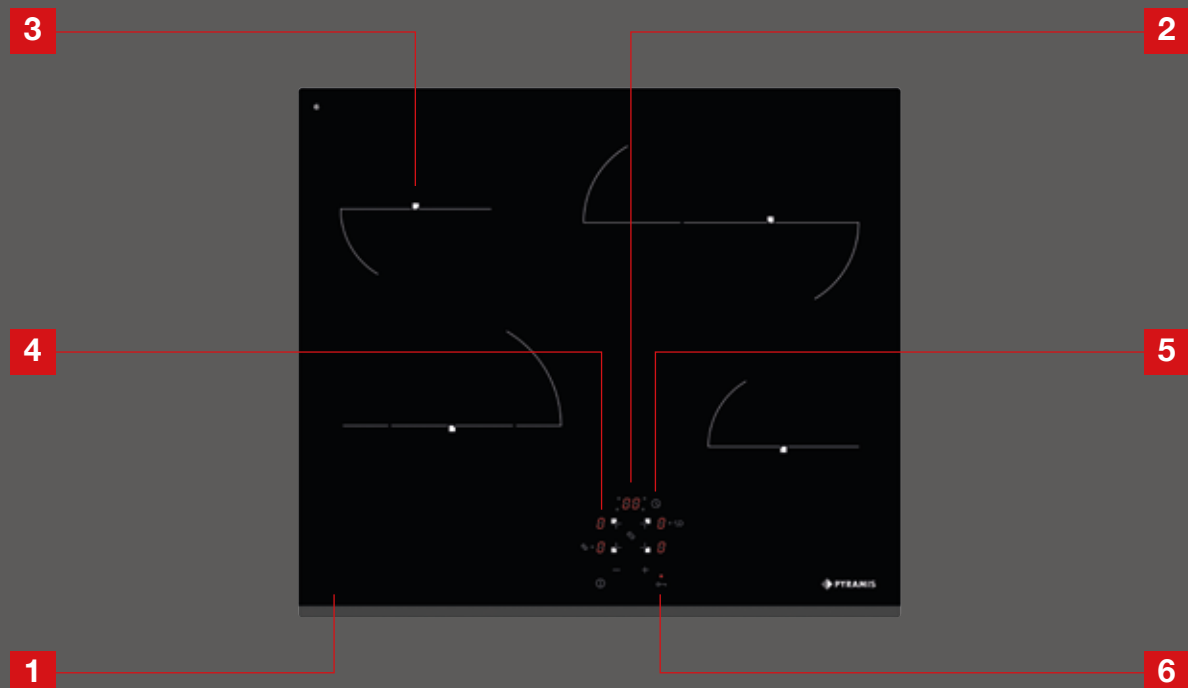

Hob profiles

Inox framed, frameless or beveled hobs that contribute to the style and determine the aesthetics of your kitchen.

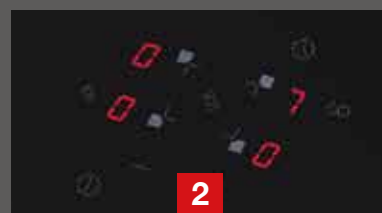

Control

Use the high tech touch controls or rheostatic knobs to easily and safely operate your appliance.



Overflow safety device

OSD turns the hob off, in case of fluid overflow on the appliance's surface while cooking, ensuring maximum safety.



Bridge

The Bridge system allows you to join two cooking zones making cooking with larger pots and pans, very easy.



Pause function

The pause function stops cooking and continues with the same settings after the reactivation.



Booster zone

Speeds up the cooking time, providing a higher power level for 5 minutes straight.

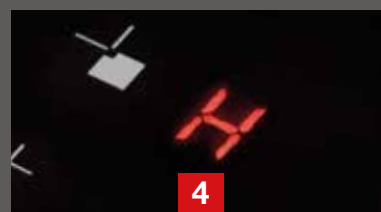

Residual heat indicator

A red digital indicator that warns that the relevant zone is still hot.

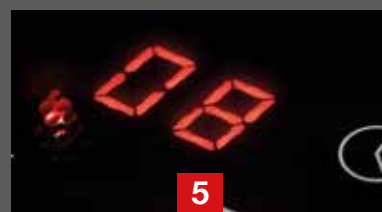

Timer

Automatically terminates the operation of the hob at the end of the desired cooking time.

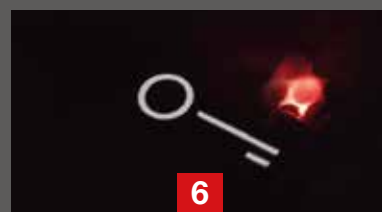

Safety lock

All hob functions can be locked to prevent accidental activation or child intervention.



Keep warm

The Keep warm function keeps the food in constant temperature of 70 °C until serving time, while preserving its taste and freshness.

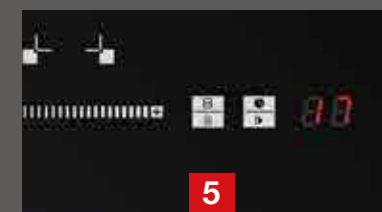

Individual cooking zone timer

The Individual cooking zone timer can be set for up to 99 minutes. The timer switches the hob off automatically when the selected time elapses.

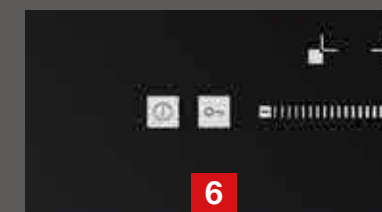

Safety lock

All hob functions can be locked to prevent accidental activation or child intervention.

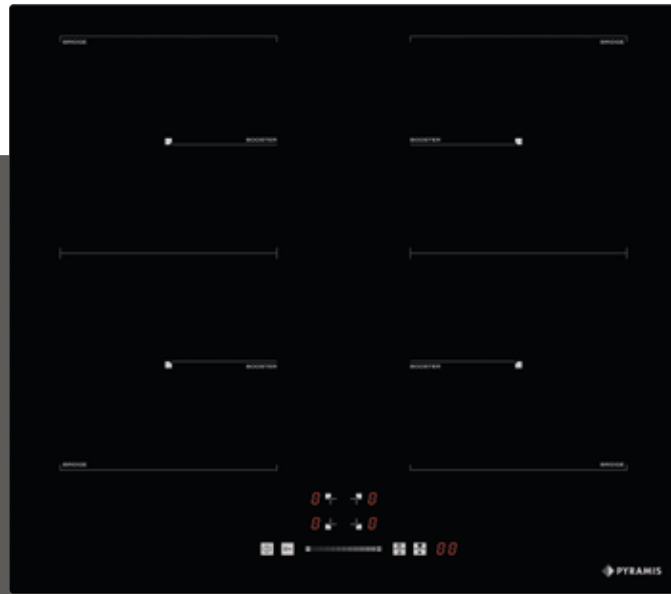

174020140
Induction Hob Frameless
PHI63432FMB

- Features**
 Dimensions: 59x52x6cm
 Cut-out dimensions: 56,5x49,5cm
 Control: Touch with slider
 9 power levels
 Residual heat indicator
 Individual cooking zone timer function
 Bridge
 Safety lock
 Pause function
 Boost function
 Keep warm function
 Power management
 Overflow safety device
 Frameless

4 Induction Zones



174020080
Induction Hob Frameless
PHI62430FMB

- Features**
 Dimensions: 59x52x6cm
 Cut-out dimensions: 56,5x49,5cm
 Control: Touch
 9 power levels
 Residual heat indicator
 Individual cooking zone timer function
 Safety lock
 Pause function
 Boost function
 Keep warm function
 Power management
 Overflow safety device
 Frameless

4 Induction Zones

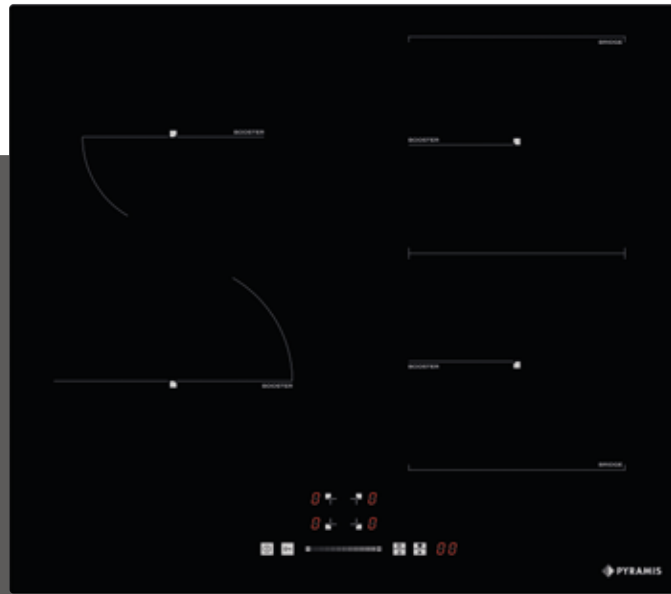

174020130
Induction Hob Frameless
PHI62432FMB

- Features**
 Dimensions: 59x52x6cm
 Cut-out dimensions: 56,5x49,5cm
 Control: Touch with slider
 9 power levels
 Residual heat indicator
 Individual cooking Zone timer function
 Bridge
 Safety lock
 Pause function
 Boost function
 Keep warm function
 Power management
 Overflow safety device
 Frameless

4 Induction Zones

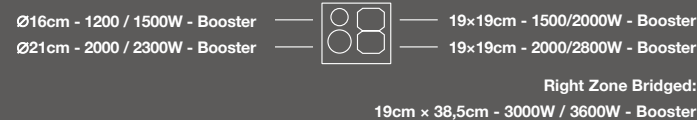

174020070
Ceramic Hob Touch Beveled
PHC61611BFB

- Features**
 Dimensions: 58x51x5cm
 Cut-out dimensions: 56x49cm
 Control: Touch
 9 power levels
 Residual heat indicator
 Timer
 Safety lock
 Overflow safety device
 Beveled front

6 Highlight Zones



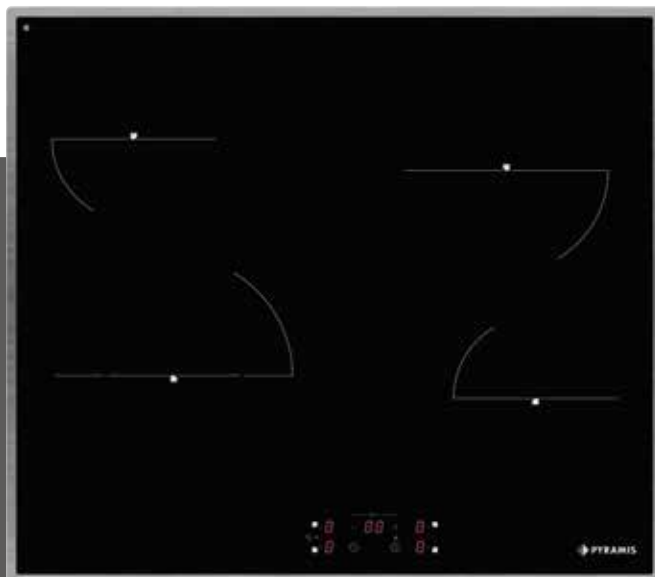

174020060
Ceramic Hob Touch with Inox Frame
PHC61510IFB

- Features**
 Dimensions: 58x51x5cm
 Cut-out dimensions: 56x49cm
 Control: Touch
 9 power levels
 Residual heat indicator
 Timer
 Safety lock
 Overflow safety device
 Inox frame

5 Highlight Zones

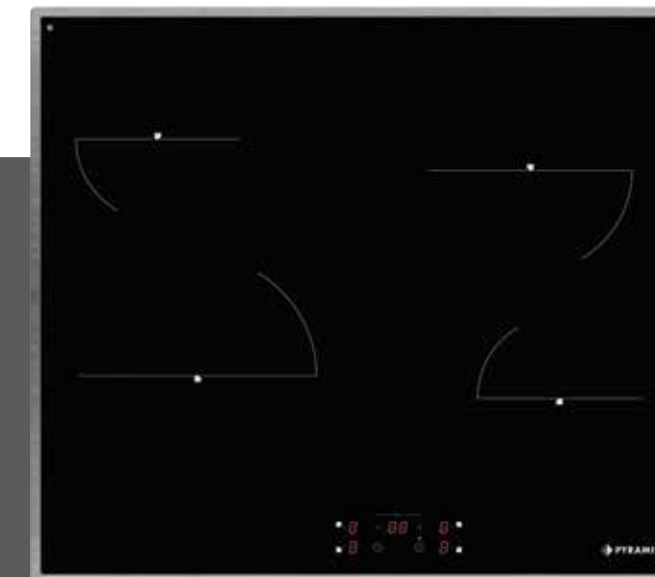

174020040
Ceramic Hob Touch with Inox Frame
PHC61410IFB

- Features**
 Dimensions: 58x51x5cm
 Cut-out dimensions: 56x49cm
 Control: Touch
 9 power levels
 Residual heat indicator
 Timer
 Safety lock
 Overflow safety device
 Inox frame

4 Highlight Zones

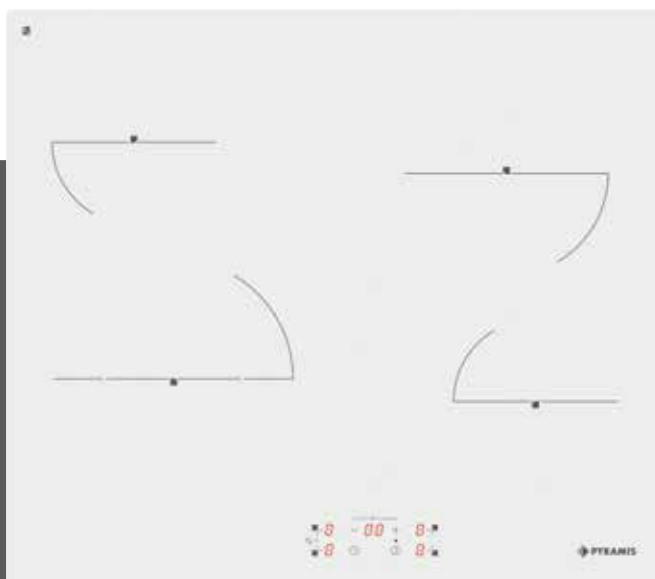

174020050
Ceramic Hob White Touch Frameless
PHC61510FMW

- Features**
 Dimensions: 58x51x5cm
 Cut-out dimensions: 56x49cm
 Control: Touch
 9 power levels
 Residual heat indicator
 Timer
 Safety lock
 Overflow safety device
 Frameless

5 Highlight Zones



174020030
Ceramic Hob Touch Frameless
PHC61410FMW

- Features**
 Dimensions: 58x51x5cm
 Cut-out dimensions: 56x49cm
 Control: Touch
 9 power levels
 Residual heat indicator
 Timer
 Safety lock
 Overflow safety device
 Frameless

4 Highlight Zones



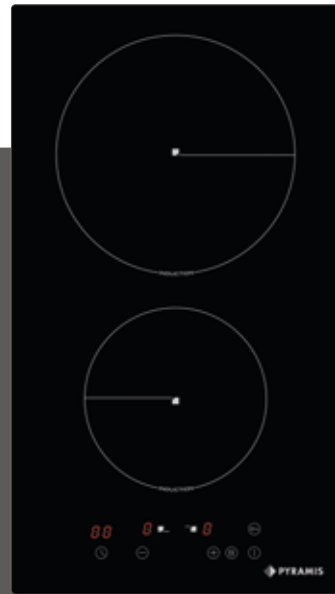

174020090
Induction Hob Frameless
PHI32230FMB

Features

- Dimensions: 29x52x6cm
- Cut-out dimensions: 26,5x49cm
- Control: Touch
- 9 power levels
- Residual heat indicator
- Individual cooking zone timer function
- Safety lock
- Boost function
- Overflow safety device
- Frameless

2 Induction Zones

Ø21cm - 2000/2300W - Booster



Ø16cm - 1200/1500W - Booster

174020010
Ceramic Hob Touch Frameless
PHC31210FMB

Features

- Dimensions: 29x51x5cm
- Cut-out dimensions: 27x49cm
- Control: Touch
- 9 power levels
- Residual heat indicator
- Frameless



2 Highlight Zones

Ø18cm - 1800W



Ø14,5cm - 1200W

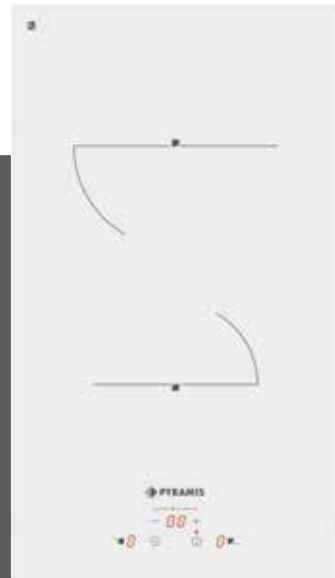

174020020
Ceramic Hob White Touch Frameless
PHC31210FMW

Features

- Dimensions: 29x51x5cm
- Cut-out dimensions: 27x49cm
- Control: Touch
- 9 power levels
- Residual heat indicator
- Timer
- Safety lock
- Overflow safety device
- Frameless

2 Highlight Zones

Ø18cm - 1800W



Ø14,5cm - 1200W

174020120
Ceramic Hob with Knobs Frameless
PHC31213FMB

Features

- Dimensions: 29x51x7,5cm
- Cut-out dimensions: 27x49cm
- Control: Rheostatic knobs
- 9 power levels
- Residual heat indicator
- Frameless



2 Highlight Zones

Ø18cm - 1800W



Ø14,5cm - 1200W



030062301

**Gas Hob Rustic Beige Metal
733071**

Features

- Dimensions: 59x51x5,1cm
- Cut-out dimensions: 56x49cm
- Control: Rustic rheostatic knobs
- Automatic ignition
- Cast iron pan support
- Flame failure device (FFD) with safety valve
- Attached gas nozzles for naturel gas
- Included accessories for LPG fuel adaptation

4 Gas Zones



030062401

**Gas Hob Rustic Black Metal
733071**

Features

- Dimensions: 59x51x5,1cm
- Cut-out dimensions: 56x49cm
- Control: Rustic rheostatic knobs
- Automatic ignition
- Cast iron pan support
- Flame failure device (FFD) with safety valve
- Attached gas nozzles for naturel gas
- Included accessories for LPG fuel adaptation

4 Gas Zones





PYRAMIS METALLOURGIA A.E.

HEADQUARTERS - PLANT

17th km Old National Road Thessaloniki - Serres
P.O. Box 10 278
54110, Thessaloniki
Greece

Tel.: +30 23940 56751
Fax.: +30 23940 56745

PYRAMIS SHOWROOM

198 Kifisias Ave.
154 51 N. Psychiko, Athens

Tel.: +30 210 5776742 - 3
Fax.: +30 210 5776747

exportsales@pyramis.gr
www.pyramisgroup.com



follow us @PyramisGroup